

DCN: DCN-0211
Change: Initial Release

Changed: 12/02/14
B Nagel

Approved: 04/01/15
J Gamble

Cable Specifications:

- Temperature Range: -40C ~ 105C
- Contact Current Rating: 2A
- Voltage Rating: 30V
- Certification: IP67
- Conductors: 4 x 26 AWG (A1,B1); 3x24 AWG (B2)

Material Specifications:

- Cable Jacket: Black PUR
- Conductor Jacket: PVC
- Connector Nut: Brass M8X1.0 with Nickel Plating
- Terminal Housing: Nylon or TPU
- Connector Terminals: Brass with Gold Plating
- Connector Overmold: Black TPU

Wiring Diagram:

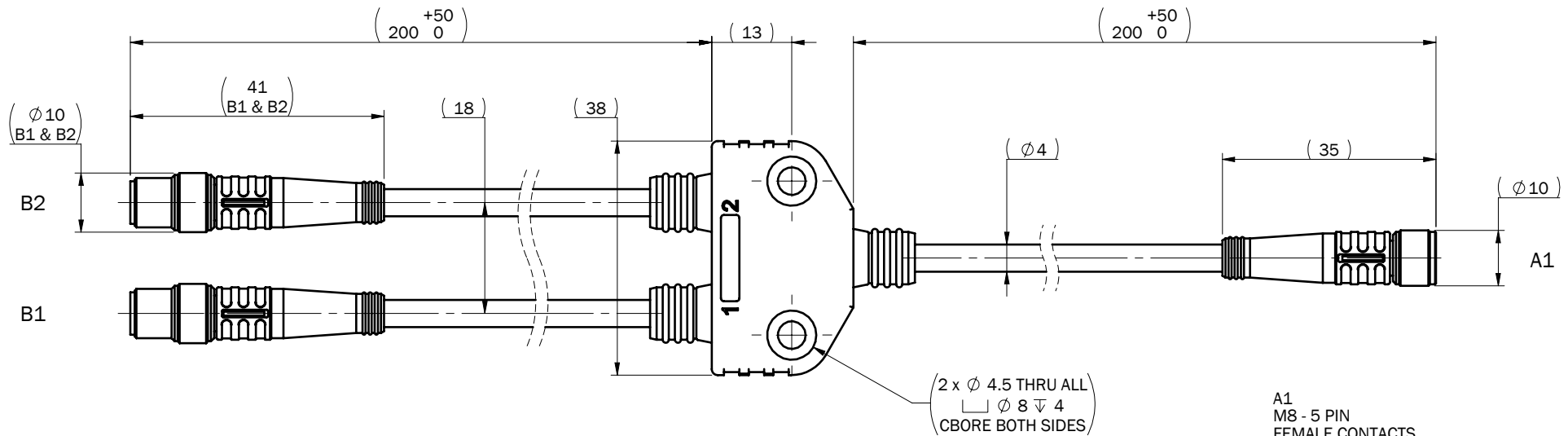
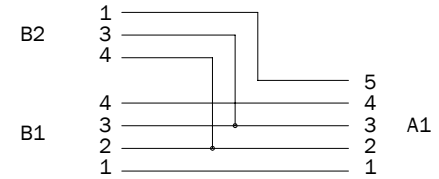

B1
M8 - 4 PIN
MALE CONTACTS

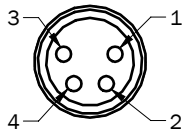

Pin #	Wire
1	Brown
2	White
3	Blue
4	Black

B2
M8 - 3 PIN
MALE CONTACTS

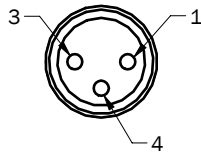

Pin #	Wire
1	Brown
3	Blue
4	Black

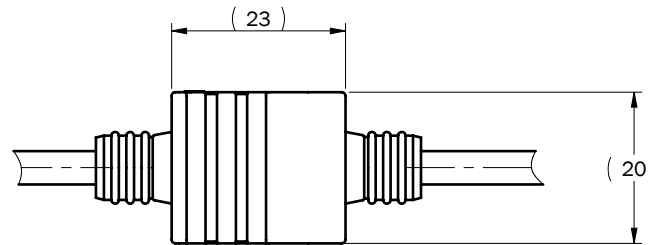

A1
M8 - 5 PIN
FEMALE CONTACTS

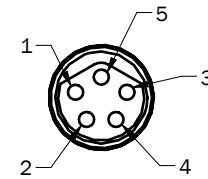

Pin #	Wire
1	Brown
2	White
3	Blue
4	Black
5	Grey

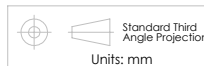

Standard Third Angle Projection
Units: mm
Unless specified otherwise:
Refer to ISO 2768-mK
for tolerances

Break Sharp Edges

Drawing Name:

ZS-A-14001-OUTL
S2 Splitter Cable

Material:
PVC; TPU

Finish:
None

Drawn: B Nagel

Date: 12/02/14 Rev: A

Model: V25-S2 Project:

Size: A Scale: 1:1 Sheet 1 of 1



35 Nutmeg Drive
Trumbull, CT 06611
(203) 375-3100
www.enfieldtech.com
This information is proprietary to
Enfield Technologies and may be
further protected by trademarks,
copyrights, or patents.